

Lock Model G200

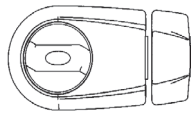

- The lock is assembled to be installed on the left-handed door. To install the lock on the right-handed door you should:
 - unscrew the lock cover (1),
 - turn the lock unit as shown in the picture (2).

Lock Model N200

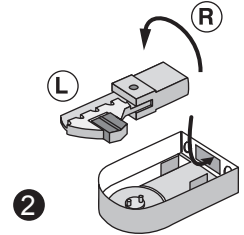
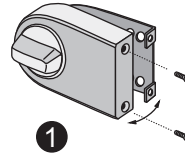
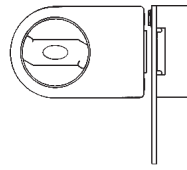

- The lock can be installed 1 15/16" (A) or 2 3/8" (B) from the door edge as shown in the picture (3). Set the clutch accordingly as shown in the picture (4). Use the hole cutter for the cylinders of the diameter 1 5/32" (30 mm).

A = 1 15/16" (50 mm)

B = 2 3/8" (60 mm)

C = 1 5/32" (30 mm)

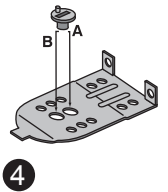
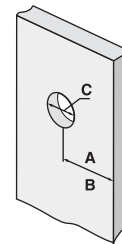

- Insert the cylinder from the outside of the door and secure it in place with the clamp plate (5).
Note: Make sure that the cylinder stays in the centered position. Cut the spindle at the point that will position it to the correct length (6).

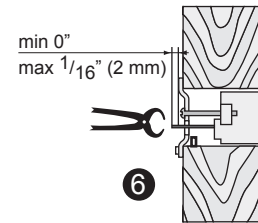
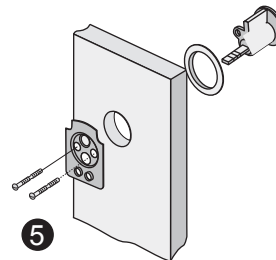

- Place the backplate on the clamp plate and secure it with 4 screws as shown in the picture (7). Make sure that the spindle stays in the spindle hole in the clutch. Fix the lock body to the backplate.
Note: Use the shorter screws for fixing the backplate to the door and the longer screws for fixing the lock keep to the frame.

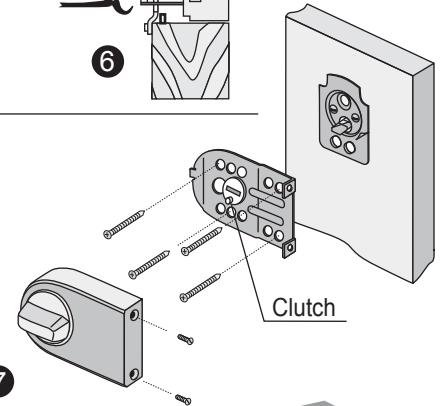

Refers to G200:

- Using the screws, fix the lock keep to the frame. If necessary, use the adjustment plates. Then fix the cover to the lock keep (8).

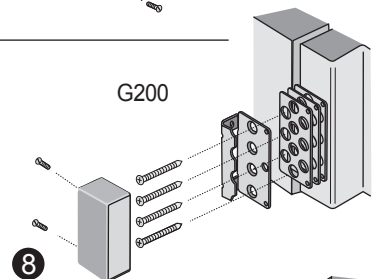

Refers to N200:

- Using the screws, fix the lock keep to the frame. If necessary, use the adjustment plates. Fix the door limiter to the upper hole of the lock keep, as shown in the picture (9). Using the flat bladed screwdriver, fix the plastic cap in the bottom hole of the lock keep until it's completely hidden.

